

M530 series Arbitrary Waveform Generator
User's Guide
Version 1.01



Copyright © 2006-2007 ETC s.r.o.

Thank you for choosing a product of ETC s.r.o. We believe it will fulfill your expectations. Please help us in providing you the best possible service by filling out the registration form at the ETC website.

Should you need any information or have any additional questions, please do not hesitate to contact us either via mail, phone or preferably e-mail. Our contact details are as follows:

Address:

ETC s.r.o.
Rosinská cesta 8
010 08, Žilina
Slovak Republic

Phone:

+421-41-5652687

Fax:

+421-41-5652687

Internet:

URL: <http://www.etc.eu>
e-mail: support@etc.eu - technical support
sales@etc.eu - sales
info@etc.eu - other information

Contents

Package contents	6
Limited Warranty	6
Software License Agreement	6
Precautions	7
1. Installation.....	8
1.1. Requirements	8
1.2. Hardware installation	8
1.3 Software installation	8
2. Hardware.....	9
2.1. Hardware description	9
3. Basic information.....	11
3.1. Layout of the front and rear panel.....	11
3.2. Vocabulary	11
4. Main window	13
4.1. Controlling settings of the outputs.....	13
4.1.1 Setting the output voltage	14
4.1.2. Displaying the output level	15
4.1.3. Setting the output voltage shift	15
4.1.4. Load setting.....	16
4.1.5. Setting the output attenuator of “L” output.....	16
4.1.6. Switching off the outputs	16
4.1.7. Filter cut-off frequency setting	17
4.2. Setting frequency	17
4.2.1. Setting waveform (standard format) frequency	17
4.2.2. Setting waveform (arbitrary format) frequency	18
4.3. Triggering controls.....	19
4.3.1. “Single” mode	19
4.3.2. “Period” mode.....	20
4.4. Waveform screen	20
4.5. Main menu	23
4.6. Options window	23
5. Waveform editors.....	25
5.1 Standard waveform editor.....	25
5.2. The Math editor.....	25
5.3. Freeform editor	31
5.4. Import from ASCII	33
6. Performance characteristics	35
6.1. Outputs.....	35
6.2. Waveform generation.....	35
6.3. Synchro	36
6.4. Power	36
6.5. Mechanical characteristics	36

List of figures and tables

Fig. 2.1.1. – Block diagram of the generator	9
Fig. 3.1.1. – Front panel	11
Fig. 3.1.2. – Back panel	11
Fig. 4.1. – The main window	13
Fig. 4.1.1. – Outputs settings	14
Fig. 4.1.3.1. – The shift edit boxes.....	15
Fig. 4.1.4.1. Setting the load	16
Fig. 4.1.5.1. – Output attenuator controls	16
Fig. 4.1.6.1. – Controlling the activity of the outputs	16
Fig. 4.1.7.1. – Filter setting controls	17
Fig. 4.2.1.1 – Setting frequency of “Standard” waveform.....	17
Fig. 4.2.1.2. – Frequency edit boxes	17
Fig. 4.2.1.3. – Displayed frequency range controls	18
Fig. 4.2.2.1. – Setting frequency of “Arbitrary” waveform.....	18
Fig. 4.2.2.2. – Frequency edit boxes	18
Fig. 4.2.2.3. – Displayed frequency range controls	19
Fig. 4.3.1. – Triggering controls	19
Fig. 4.3.2. – Mode setting controls	19
Fig. 4.3.1.1. – Manual trigger event selection	19
Fig. 4.3.1.2. – External trigger event selection	20
Fig. 4.3.2.1. – Period mode controls	20
Fig. 4.3.2.2. – Arm mode controls	20
Fig. 4.4.1. – The waveform screen.....	21
Fig. 4.4.2. – Waveform properties window	21
Fig. 4.4.3. – Waveform pop-up menu	21
Fig. 4.4.4. – New waveform window.....	22
Fig. 4.4.5. – List of editors.....	22
Fig. 4.4.6. – New waveform pop-up menu	22
Fig. 4.4.7. – Waveform creation editors	22
Fig. 4.6.1. – The “Options” window	23
Fig. 5.1.1. – The standard waveform editor screen	25
Fig. 5.2.1. – Math editor mode selection	26
Table 5.2.2. – List of functions	26
Fig. 5.2.3. – x range setting.....	26
Fig. 5.2.4. – Output waveform calculated with “Normalization” option on.....	27
Fig. 5.2.5. Defining waveform with “Normalize” option off	28
Fig. 5.2.6. – Manipulating with sections.....	28
Fig. 5.2.7. – Parameters of the section in advanced mode.....	28
Fig. 5.2.8. – Defining part of the waveform	29
Fig. 5.2.9. – Waveform assembled from three parts.....	30
Fig. 5.2.10. – Using “Y” and “Z” constants.....	31
Fig. 5.3.1. – The freeform editor main screen	31
Fig. 5.3.2. – Horizontal waveform position controls	32
Fig. 5.3.3. – Direction of drawing.....	32
Fig. 5.3.4. – Curve mode controls.....	32
Fig. 5.3.5. – Smoothness setting	33
Fig. 5.4.1. – Import from ASCII file.....	33

Fig. 5.4.2. – Import settings	34
Fig. 5.4.3. – Postprocessing settings	34
Table 6.1.1. – Outputs	35
Table 6.2.1. – Waveform generation	36
Table 6.3.1. – Synchro	36
Table 6.4.1. – Power	36
Table 6.5.1. – Mechanical characteristics	36

Package contents

- M530 series generator – 1pc
- USB cable – 1pc
- Plug in adapter – 1pc
- installation leaflet – 1pc
- CD with software and user's guide in pdf – 1pc

Limited Warranty

The ETC s.r.o. company guarantees reliable operation of the M530 series generator in compliance with this documentation during a period of 24 months from the date of purchase.

Should a malfunction occur during the warranty period, excluding errors for which ETC can not be held responsible, ETC guarantees the repair of the product or its replacement with a new or repaired one free of charge.

The ETC company shall not be responsible for malfunctions on the device caused by an accident, incorrect manipulation, unauthorized interventions or similar.

When requesting the warranty service, the customer should send the device in its original package to the dealer from whom it was purchased or directly to the ETC company. The warranty certificate together with a description of the defect or malfunction should be included in the package. The customer agrees that a new or repaired product to be shipped would be insured against damage or loss during the transport and that he will cover the costs for the shipment and insurance.

Software License Agreement

This legal document is an agreement between you, the end user, and ETC s.r.o. By installing this product on your computer, you are agreeing to become bound by the terms of this agreement and warranty conditions.

1. GRANT OF LICENSE. ETC s.r.o. as Licensor, grants you, the Licensee, a nonexclusive right to use and display this copy of the M530 software (hereinafter the "SOFTWARE"), this EM530 device and accompanying written materials, on a single COMPUTER at a single location and only together so long as you comply with the terms of this License.

2. OWNERSHIP. As the LICENSEE, you own the magnetic or other physical media on which the SOFTWARE is originally or subsequently recorded or fixed, but an express condition of this License is that ETC s.r.o. retains title and ownership of the SOFTWARE recorded on the original disk copy(ies) and all subsequent copies of the software, regardless of the form or media in or on which the original and other copies may exist. This License is not a sale of the original SOFTWARE or any copy.

3. COPY RESTRICTIONS. This SOFTWARE, EM530 device and accompanying written materials are copyrighted. Unauthorized copying or copy attempt of the EM530 device, including module which has been modified or included with any other system, or of written materials is expressly forbidden. It is, however, allowed to pass SOFTWARE on as the DEMO version. You may be held legally responsible for any copyright infringement which is caused or encouraged by your failure to abide by the terms of this License.

4. **DISCLAIMER OF THE WARRANTY OF ANY KIND CONCERNING SOFTWARE.** This SOFTWARE and accompanying written materials are provided "AS IS" without a warranty of any kind. Further, ETC s.r.o. does not warrant, guarantee or make any representations regarding the use, or the results of use, of the SOFTWARE, EM530 device or written materials in terms of correctness, accuracy, reliability, currentness, or otherwise. The entire risk as to the results and performance of the software is assumed by you.

Precautions

Please observe following recommendations to avoid possible problems that might occur while using the generator.

- read the User's Guide
- always connect the device using a cable included in a package. If it is not possible, always use USB 2.0 cable.
- do not connect any voltage source to the outputs.
- never connect any voltage out of -10V to +13V range to the external trigger (Si) input (frequencies of up to 20 kHz). For frequencies higher than 20 kHz the voltage range of -0.5 to +4V is recommended.
- never connect any voltage to the generator ground. It may result in the device, or computer damage.
- use only the supplied wall adapter. If it is not possible, you can use any DC voltage source in range of 10 to 18V able to supply at least 300mA. The connector's polarity is not important. Please be sure that no of the power supply poles are directly connected to the ground of the device. The power supply should be fuse protected against of overloading.
- do not open or dismantle the case, it will void any warranty. There no user serviceable parts inside.

1. Installation

1.1. Requirements

Minimum configuration:

- PC PENTIUM compatible computer
- 64MB RAM
- CD-ROM
- VGA with resolution 800 x 600
- USB port 1.1
- mouse or other tracking device
- at least 20MB free space on the hard drive
- MS Windows 98 SE, ME, 2000 or XP

Recommended configuration:

- PC PENTIUM compatible computer with speed of at least 800MHz
- 256MB RAM
- CD-ROM
- VGA with resolution at least 1024x768
- USB port 2.0
- mouse or other tracking device
- at least 20MB free space on the hard drive
- MS Windows 98 SE, 2000 or XP

1.2. Hardware installation

Connect one side of the cable to the computer and the other one to the device. Proceed with the software installation.

WARNING: Always use the cable included in the package. Using the improper cable can disable communication with the computer.

1.3 Software installation

The software and the device drivers are located on the enclosed CD. Insert the CD into the CD-ROM drive. Then follow the instructions of the setup program that should launch automatically. If the CD autorun is not enabled in your computer's settings, please run file *autorun.exe* from the CD.

2. Hardware

The information contained in this chapter will help you understand features of your device.

2.1. Hardware description

The M530 series arbitrary waveform generator connects to computer via USB 2.0. The device accuracy is assured by the stability of the circuits and by the calibration constants stored directly in the device.

The output waveform can be defined by maximum of 16384 samples with 12 bits resolution. The generator is equipped with two outputs. The output range of low level output (L) is $\pm 4.5\text{V}$ with an output resistance of 50 Ohm. It is calibrated for up to 10 MHz. The high level output (H) offers $\pm 25\text{V}$ voltage range, with 600 Ohm resistance. It is calibrated for up to 200kHz.

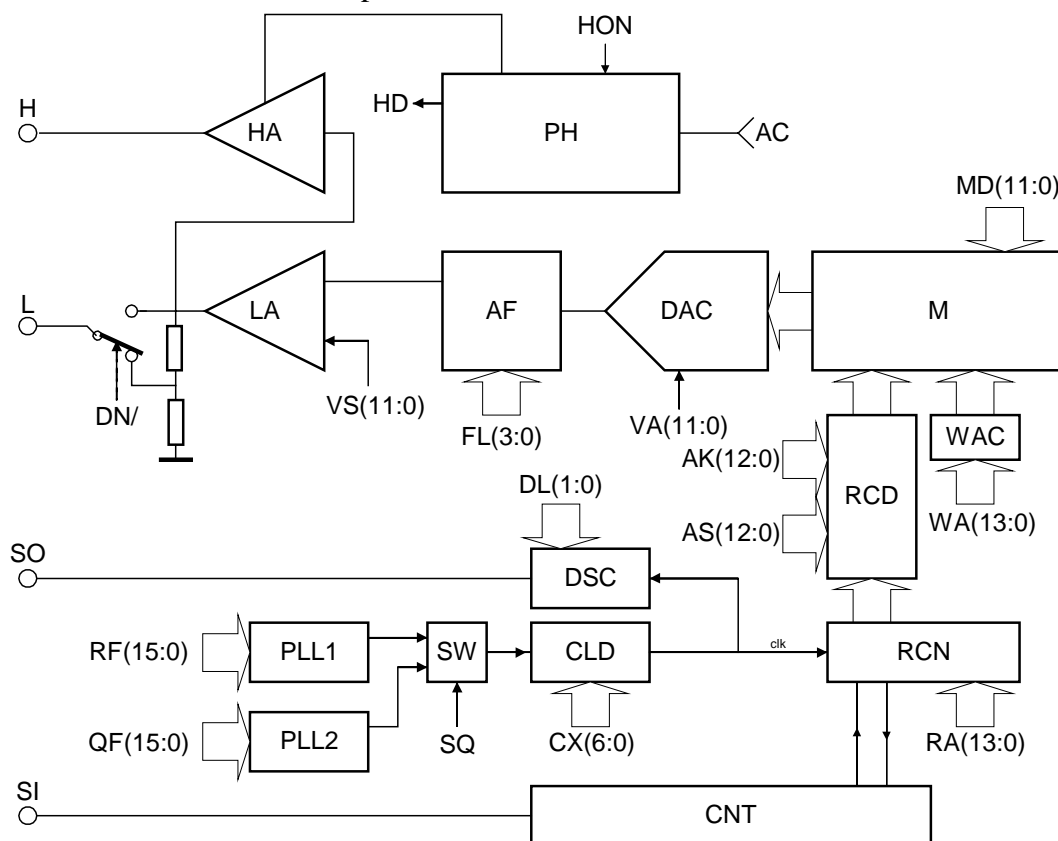

Fig. 2.1.1. – Block diagram of the generator

The block diagram of the generator is on the picture 2.1.1. The output amplifier LA is connected to attenuator with settable attenuation of 0 or 20dB. The output of this attenuator is connected to the output connector. The LA output amplifier together with HA output amplifier are controlled by output of fast DA converter (DAC) via low pass filter with settable cut-off frequency (AF). The samples of the output waveform are stored in local storage (M) of the generator. The sample handling is provided by (CNT, DSC, CLD, RCN, RCD, WAC) modules. They are clocked by PLL controlled generators to ensure smooth tuning throughout the whole frequency range.

The generator works in one of following operation modes:

- PERIODIC - The output waveform is generated periodically with no possibility of external synchronization. The output synchronization pulse is issued at the beginning of each output period through the synchronization output (SO).
- TRIGGERED – The waveform generation is started by the input synchronization pulse from the SI connector.
- MANUAL – The waveform generation is user-triggered through the button click.

The device is powered mainly from the USB interface. However, when using the high level output, it is necessary to connect the supplied wall socket adapter. The PH module works as the high level output power supply.

3. Basic information

3.1. Layout of the front and rear panel

There are four connectors and two LEDs on the front panel. The BNC connectors represent the low and high level outputs (L and H) and the input and output synchronization signals (SI, SO). The LEDs are located on the left and the right side of the front panel. The meaning of the left side LED is as follows:

- Green color – the high level output is powered
- Orange color – the thermal shut down condition of high level amplifier is met.



Fig. 3.1.1. – Front panel

The right side LED indicates the state of the device and its communication activity. The different colors have following meanings:

- Red color – the device is powered, but not configured.
- Green color – the device is powered and properly configured
- Orange Color - the communication is in progress.

On the rear panel there are three connectors. The center one is the USB interface connector, the right one is the external power adapter input and the third 10 pin connector is an auxiliary connector reserved for future use.

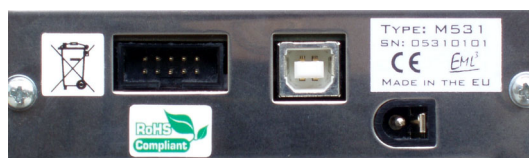

Fig. 3.1.2. – Back panel

WARNING: Use only the supplied wall socket adapter. If it is not possible you can use any DC power supply with output voltage from 10 to 18 V and at least 300mA of output current. The polarity of connector is not important. Please assure, that no pole of power supply is connected directly to the ground of the instrument (via measuring cable ground for example).

3.2. Vocabulary

This chapter explains the technical vocabulary used throughout the text.

Click – Position the mouse cursor over the chosen object. Then press and release the left mouse button.

Double-Click – Two fast successive clicks.

Drag – Move the mouse cursor over the object you want to drag. Press the left mouse button and hold it down. Now you can drag the chosen object when moving the mouse cursor. After releasing the mouse button the object moves to the new location.

Enter the value into the edit box – Click the edit box. Use the keyboard to enter the desired value and confirm it by pressing the “Enter” key on the keyboard.

Insert the value into the edit box – Click the edit box. Use the keyboard to enter the desired value.

Set the value using the scroll bar – It is possible to change a value simply by dragging the scroll bar slider. Clicking the arrows of the scroll bar increases or decreases the value by smallest steps. Clicking in between the slider and the arrows changes the value by larger steps.

Select the value from the combo box – Open the list of all possible values of the combo box by clicking it. Then set the desired value by clicking it.

4. Main window

After starting the application the main window appears. It contains all the controls of the generator.

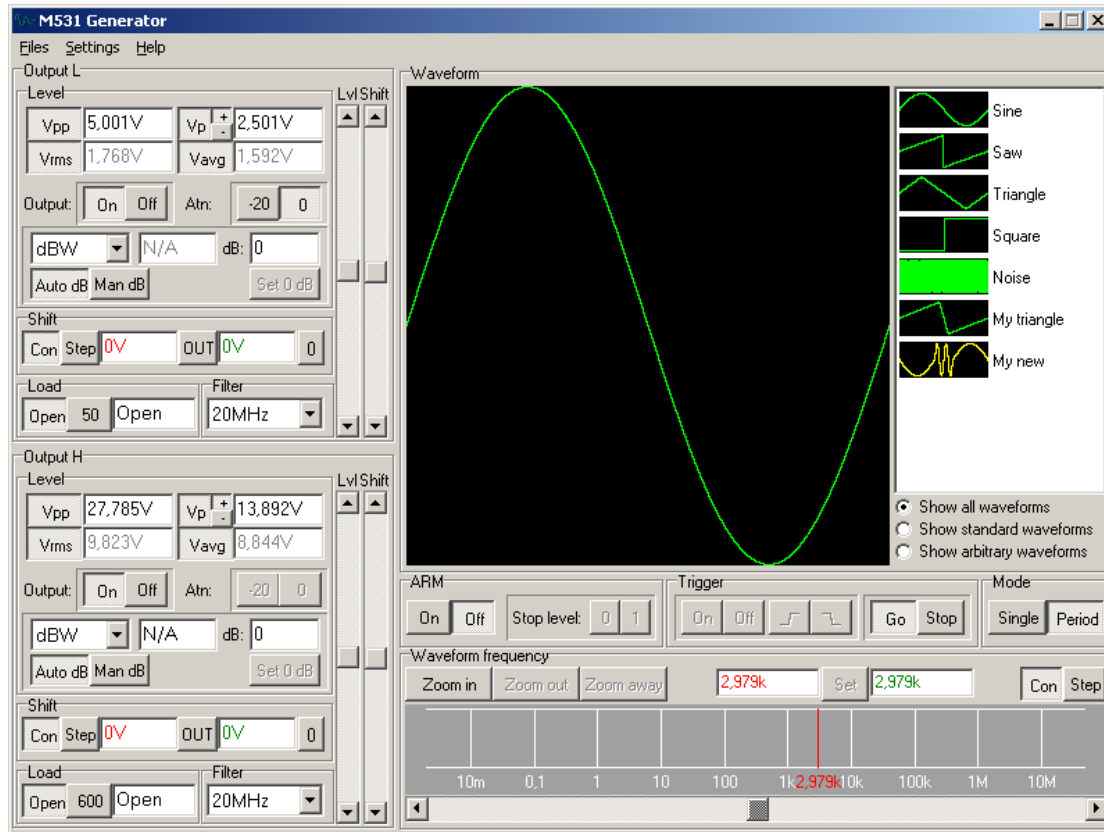

Fig. 4.1. – The main window

4.1. Controlling settings of the outputs

Elements for controlling the settings of the outputs are located on the left side of the main window.

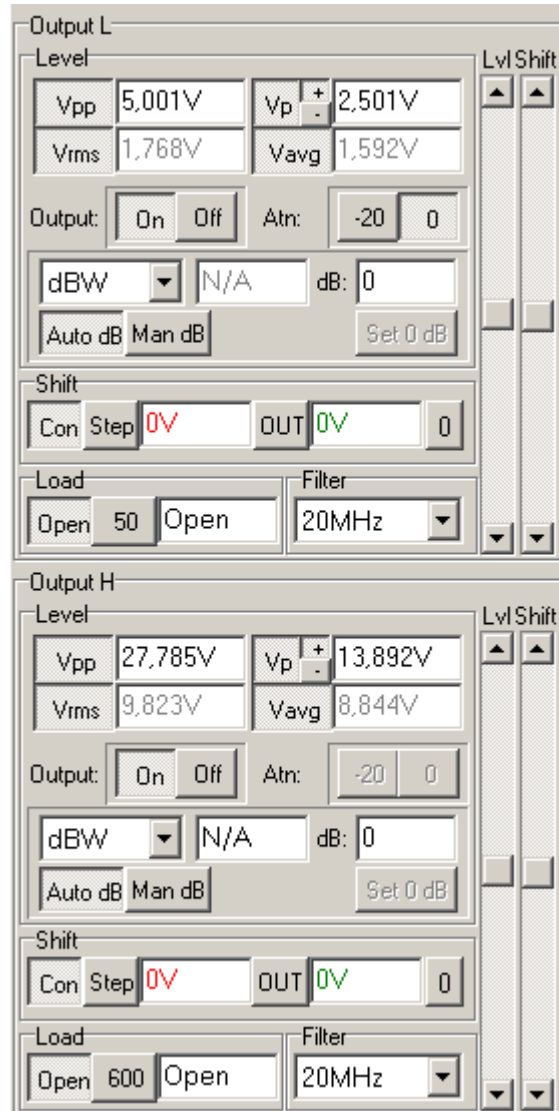

Fig. 4.1.1. – Outputs settings

Using these elements it is possible to control amplitude and DC shift of the output waveform. It is also possible to display the proper amplitude depending on the connected load and set the low pass filter cut-off frequency.

4.1.1 Setting the output voltage

The output voltage can be adjusted by dragging the vertical scroll bar labeled “Lvl”. The output level can be set also relatively to the reference value, which is displayed in the edit box labeled “dB”. The reference value can be set in following two modes:

- **Auto dB** - the reference value is continuously adjusted to the output level. Please note that the “dB” edit box always displays 0 in this mode.
- **Man dB** - the edit box (“dB”) shows the relation of output level value to the reference value. Clicking the “Set 0 dB” button sets the reference value to the current output level.

It is possible to set the output level in following manner:

- Enter the value into the “dB” edit box
- Enter the value into the “Vpp” or “Vp” edit boxes.

TIP: When the value entered to the edit box is out of range, the device sets the closest possible one.

WARNING: When the output voltage is outside of recommended range, the “Lvl” label turns red. In this case, the value of output voltage may not meet the performance characteristics of the device.

4.1.2. Displaying the output level

The edit boxes display following information:

- Vpp – Peak to peak voltage
- Vp – Minimum or maximum output voltage of the waveform (using the “+” or “-“ buttons)
- Vrms - Root Mean Square value
- Vavg – Average value
- dBW, dBmW – Relation of power on the connected load with respect to 1W or 1mW
- dBmV, dBuV – Relation of the Vrms of output voltage with respect to 1mVrms or 1uVrms

WARNING: The value of Vp depends on the output shift. When the “Vrms from AC” option is turned off, the Vrms and Vavg value depend on shift as well.

Clicking the button switches the “Vpp”, “Vp”, “Vrms”, or “Vavg” edit boxes on or off. The “Vp” edit box can display the maximum or minimum value of the waveform depending on which button of “+” or “-“ has been selected.

4.1.3. Setting the output voltage shift

The output voltage shift is adjustable by dragging the “Shift” scroll bar. Generally, the output voltage shift can be adjusted in following two modes:

- “Con” mode - the new shift voltage is updated in the device immediately.
- “Step” mode - the new shift voltage value is displayed in the additional (red) edit box. Clicking the “OUT” button updates the shift voltage in the device.

You can also enter precise value to the additional (red) edit box. The value set in device is displayed in the main (green) edit box.

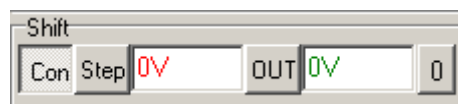

Fig. 4.1.3.1. – The shift edit boxes

Clicking the “0” button sets shift in the device to the 0V. If the “Step” mode is on, click “OUT” button to restore original shift voltage.

WARNING: When the peak voltage of the generated waveform is out of recommended range, “Shift” label turns red. In this case, the generated waveform may not meet the performance characteristics of the device.

4.1.4. Load setting

The output voltage of the generator depends on the connected load. In order to ensure the displaying of the correct voltage values, a real load value has to be provided. For providing the real load value there are two buttons and a “Load” edit box. The edit box always shows the last entered load. There are following ways to adjust the load you can:

- Click on the “Open” button - no load is assumed on the output.
- Click on the “50” (“600”) button - a load equal to the output impedance is set.

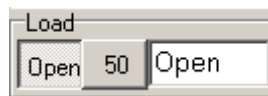

Fig. 4.1.4.1. Setting the load

- Enter the load directly into the edit box.

WARNING: Connecting a load lower than 10 Ohm can result in the distortion of output waveform.

4.1.5. Setting the output attenuator of “L” output

The output attenuator can be set to 0 or -20 dB. It is controlled by following two buttons:

- button “0” sets the attenuation to 0 dB (1:1).
- button “-20” sets the attenuation to -20dB (1:10).

The “output voltage” edit boxes always display the actual output voltage.

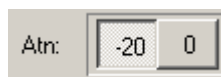

Fig. 4.1.5.1. – Output attenuator controls

4.1.6. Switching off the outputs

The “On” and “Off” labeled buttons located in the “Output” box activate or deactivate the outputs. Clicking the “Off” button deactivates outputs by setting voltage to 0V. Clicking the “ON” button reactivates the outputs.



Fig. 4.1.6.1. – Controlling the activity of the outputs

4.1.7. Filter cut-off frequency setting

A low pass filter can only be connected to both outputs simultaneously. The filter can be switched on with cut-off frequency of 20 or 40 MHz.

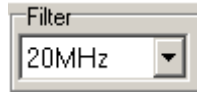

Fig. 4.1.7.1. – Filter setting controls

4.2. Setting frequency

The output waveform can be defined in one of the following formats:

- standard format – the waveform is arbitrary, length is fixed to 8192 samples
- arbitrary format – both waveform and its length are arbitrary

4.2.1. Setting waveform (standard format) frequency

The term “frequency” indicates (for standard format) the frequency of the whole waveform. For example, if the waveform is defined as two periods of the harmonic signal, the frequency on the generator’s output is the double of the selected frequency. The frequency on the output will meet the selected frequency only if the waveform contains one period of the signal. The standard format is distinguished by the “Waveform frequency” text in the top-left of the panel.

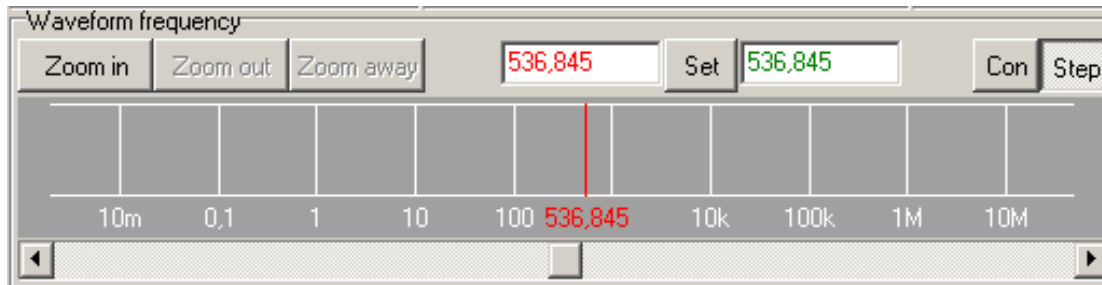

Fig. 4.2.1.1 – Setting frequency of “Standard” waveform



- The frequency can be set in following two modes:
- Con mode – all changes are updated in both the main (green) and additional (red) edit box and are immediately set to device
 - Step mode – all changes are updated only in additional (red) edit box. Main edit box (green) displays the value set in the device. Clicking the “set” button updates the value in the device.

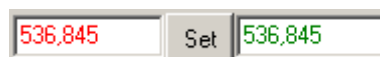

Fig. 4.2.1.2. – Frequency edit boxes

A frequency can be adjusted by dragging the red rider to a desired value. The value set in device is displayed by the green rider (red and green rider can differ only in “step” mode).

A scrollbar can be used for fine-tuning the frequency.

The frequency can be precisely specified also by entering a value into the additional (red) edit box.

TIP: The frequency is being entered in Hz units. If, however, the letter “M” follows the numeric value, the value is considered to be in MHz. If the letter “k” follows numeric value, it is considered to be a kHz value.

Clicking “Zoom in” button decreases displayed frequency range, clicking “Zoom out” increases displayed frequency range and clicking “Zoom away” sets displayed frequency range to maximum.

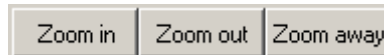

Fig. 4.2.1.3. – Displayed frequency range controls

4.2.2. Setting waveform (arbitrary format) frequency

The term “Frequency” indicates (for arbitrary format) the sampling rate. The arbitrary format is distinguished by the “Sampling rate” text in the top-left of the panel.

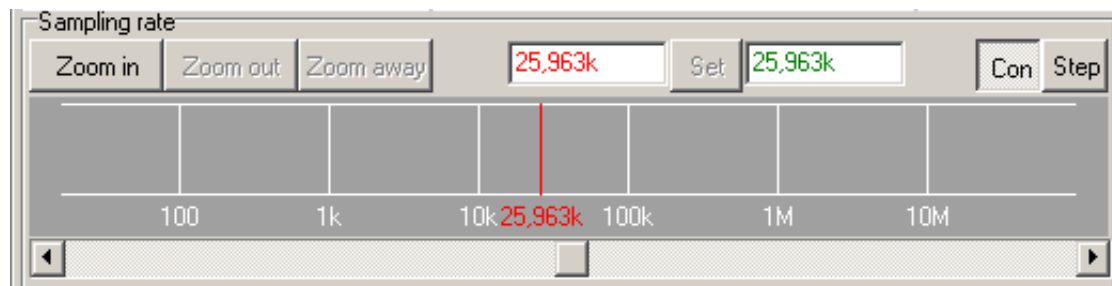
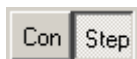

Fig. 4.2.2.1. – Setting frequency of “Arbitrary” waveform



- The frequency can be set in following two modes:
- Con mode – all changes are updated in both the main (green) and additional (red) edit box and are immediately set to device
 - Step mode – all changes are updated only in additional (red) edit box. Main edit box (green) displays the value set in the device. Clicking the “set” button updates the value in the device.

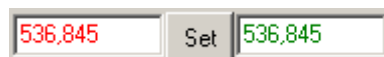

Fig. 4.2.2.2. – Frequency edit boxes

A frequency can be adjusted by dragging the red rider to a desired value. The value set in device is displayed by the green rider (red and green rider can differ only in “step” mode).

A scrollbar can be used for fine-tuning the frequency.

The frequency can be precisely specified also by entering a value into the additional (red) edit box.

TIP: The frequency is being entered in Hz units. If, however, the letter “M” follows the numeric value, the value is considered to be in MHz. If the letter “k” follows numeric value, it is considered to be a kHz value.

Clicking “Zoom in” button decreases displayed frequency range, clicking “Zoom out” increases displayed frequency range and clicking “Zoom away” sets displayed frequency range to maximum.

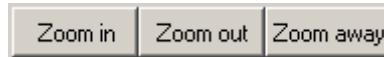

Fig. 4.2.2.3. – Displayed frequency range controls

4.3. Triggering controls

The waveform generation is controlled by trigger controls located in the middle right of the main window.

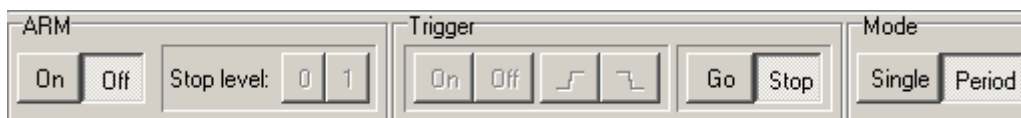

Fig. 4.3.1. – Triggering controls

Waveform can be generated in following two modes:

- Single – the waveform is generated once on synchronization event
- Period – the waveform is generated continuously (the synchronization event has no influence on generation)

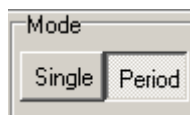

Fig. 4.3.2. – Mode setting controls

4.3.1. “Single” mode

Following two trigger events can be selected in this mode:

- Manual trigger event – clicking the “Go” button starts the generation. Turn trigger off (click “Off” button in the trigger panel) to select this mode.

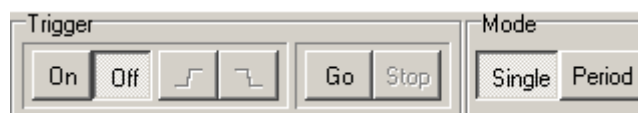

Fig. 4.3.1.1. – Manual trigger event selection



- External trigger event – rising or trailing edge on the “Si” input starts the generation. Turn trigger on (click “On” button in trigger panel) to select this mode. Click  button to select leading edge or  to select trailing edge.



Fig. 4.3.1.2. – External trigger event selection

4.3.2. “Period” mode

The waveform is continuously generated in this mode. Click “Go” button to enable generation, click “Stop” button to stop it. Please note, that when the generation is restarted (clicking “Stop” and “Go” button), the generation starts from the waveform beginning.

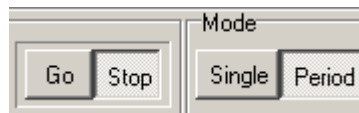

Fig. 4.3.2.1. – Period mode controls

The “Si” input can be used as “ARM” input. Click “On” button on the ARM panel to turn arm mode on. The generation is suspended if the stop value is detected on the “Si” input. Click on “0” or “1” button of the “Stop level” panel to select stop value.

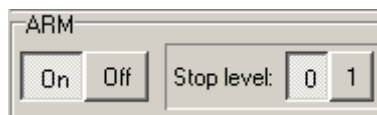

Fig. 4.3.2.2. – Arm mode controls

4.4. Waveform screen

The shape of the actual waveform and the list of an available waveforms are displayed on the waveform screen. Drag the waveform from the list to the actual waveform screen to select it. Please note, that the waveform format (“standard” or “arbitrary”) influences also frequency controls. The “standard” waveforms are displayed in the green color, “arbitrary” waveforms are displayed in yellow.

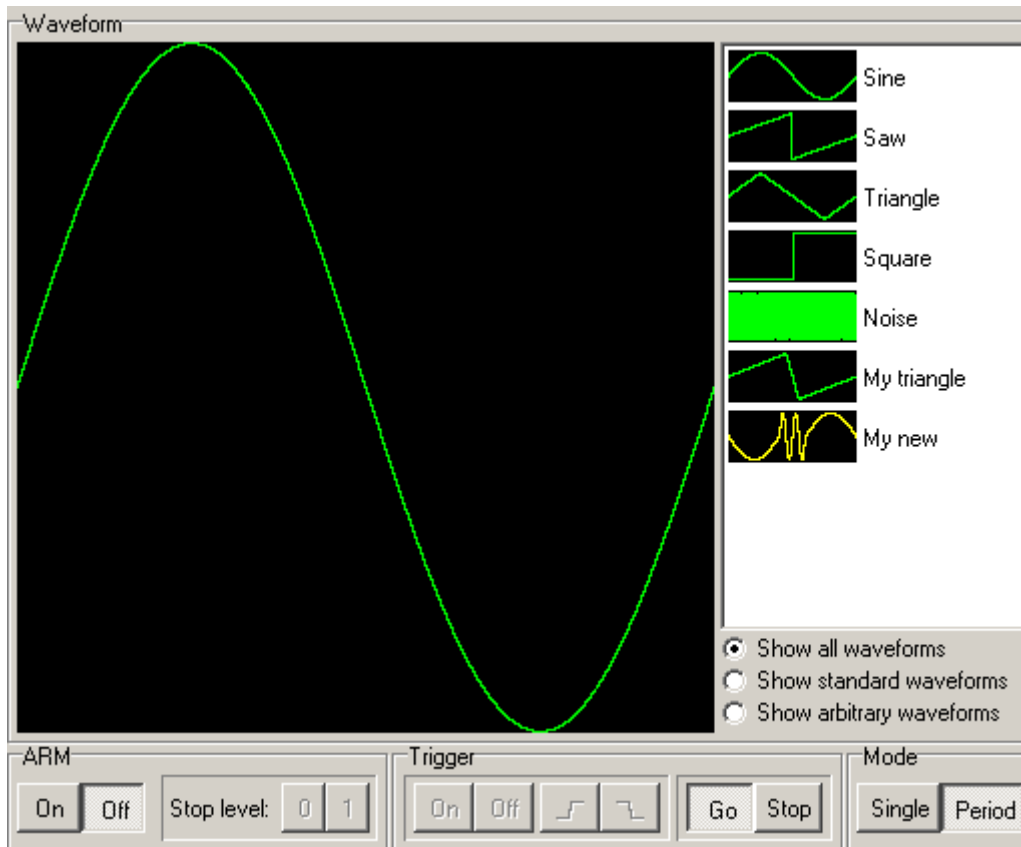

Fig. 4.4.1. – The waveform screen

Waveforms can be modified using editors.
 Double-clicking the waveform displays its properties.

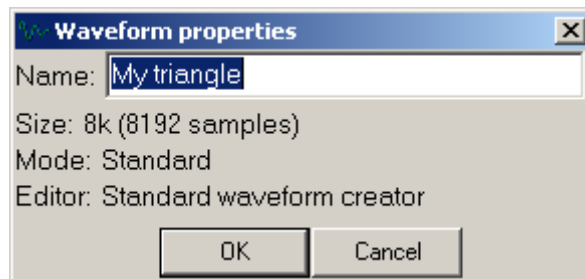

Fig. 4.4.2. – Waveform properties window

Right-clicking the waveform in the list, displays the pop-up menu, where you can select the operations with the waveform.

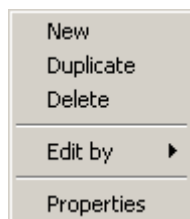

Fig. 4.4.3. – Waveform pop-up menu

Click “Delete” to remove the waveform from the list.

Clicking “Properties” displays waveform properties (this operation is same as double-click on the item).

Click “Duplicate” to create the copy of the selected waveform. The copy will be added to the end of the list.

Click “New” to open the “new wave” window, where you can select the parameters of the new waveform. You can select waveform name, size and mode in this window. Depending on the selected mode, the size can be selected from following range:

- Standard mode – the size is fixed to 8k
- Arbitrary mode – the size can be selected from 1 sample to 16k samples

Click “OK” button to create the waveform with specified parameters. The shape of the new waveform is always the 0V constant.

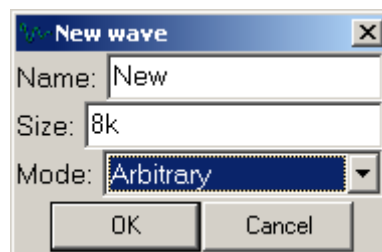

Fig. 4.4.4. – New waveform window

The “Edit by” item of the pop-up menu contains the list of editors. Clicking the item from the list starts selected editor. Please see chapter 5. for the information about editors.

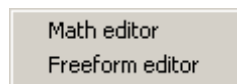

Fig. 4.4.5. – List of editors

Right-clicking the free space in the waveform list opens the pop-up menu, where you can create new waveform.

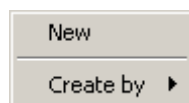

Fig. 4.4.6. – New waveform pop-up menu

Click “New” to open the “new wave” window. This window was described in previous text.

The “Create by” item contains the list of editors capable of creating the waveform. Clicking the item from the list starts selected editor. Please see chapter 5. for the information about editors.

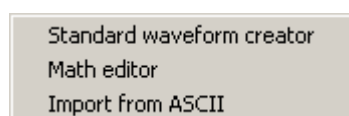

Fig. 4.4.7. – Waveform creation editors

The waveform list can be filtered by selecting filtering criteria below the list .

4.5. Main menu

The main menu consists of the following items:

Files / Exit – Exits from the application leaving the device running, but switching off the high level output.

Files / Exit (preserve H output) - Exits from application leaving the both device and high level output running

Settings / Process licence file – Loads and processes specified licence file

Settings / Options – Opens the “options” window (see chapter 4.5.1. for further details).

Help / About – Opens the “about” window.

4.6. Options window

Clicking the proper item in the main menu opens the options window.

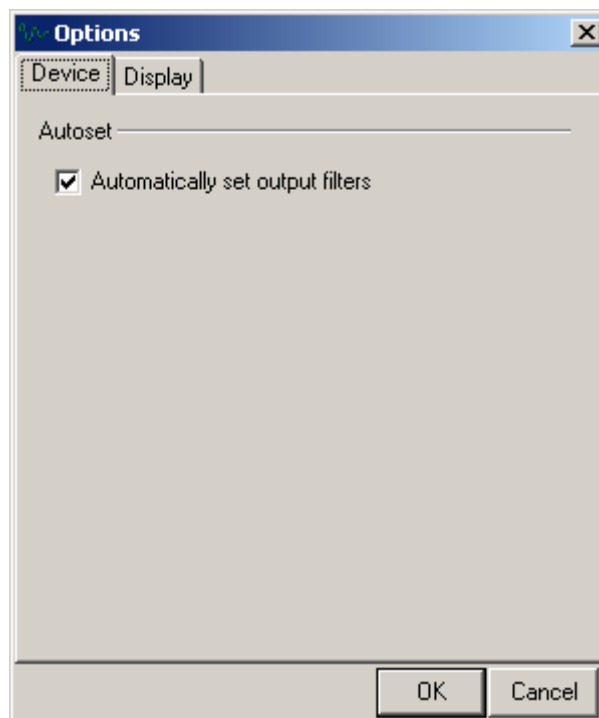

Fig. 4.6.1. – The “Options” window

Following options are available:

Device / Automatically set output filters – indicates, whether the output filter should be automatically selected to generate all major harmonics correctly and smooth output waveform

Display / Vrms from AC – indicates, whether the effective and average value of the signal will be influenced by vertical shift.

5. Waveform editors

Following editors are available for waveform creation and/or modification:

- Standard waveform editor
- Math editor
- Freeform editor
- Import from ASCII file

Please see chapter 4.4 for instructions how to activate them.

5.1 Standard waveform editor

This editor can create “sine”, “saw”, “triangle”, “square”, “noise” signals.

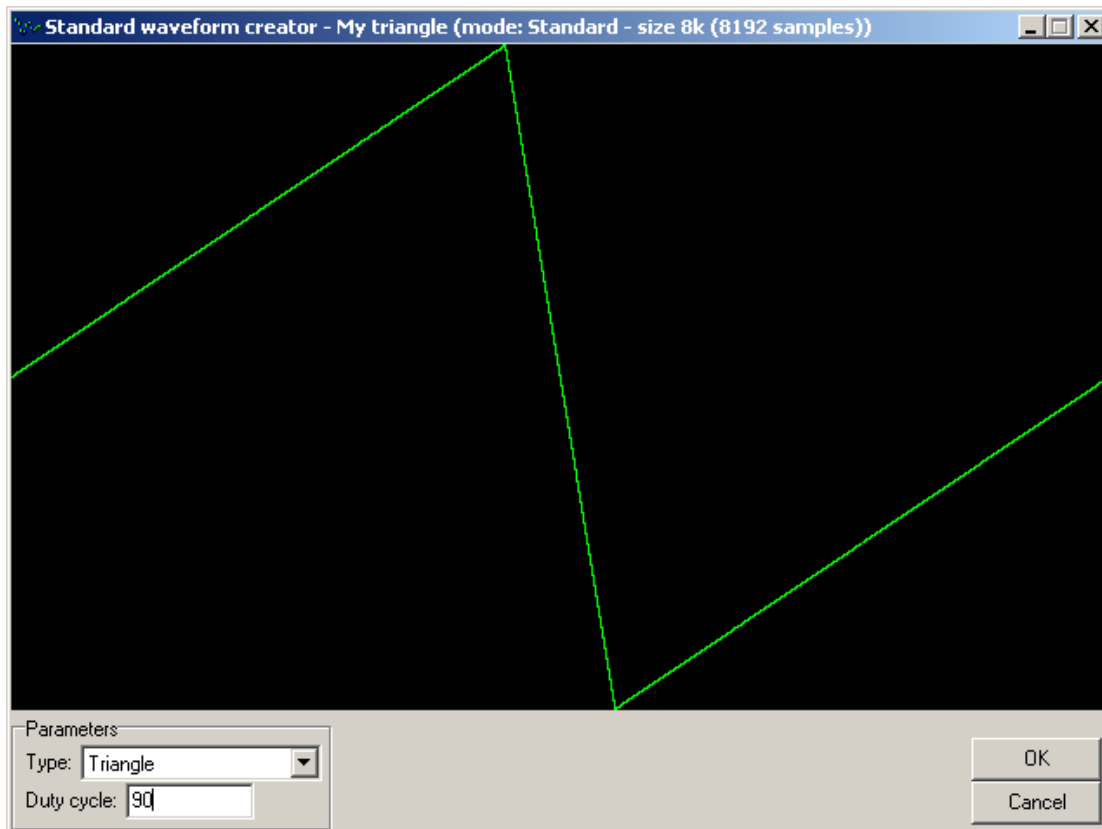

Fig. 5.1.1 - The standard waveform editor screen

The “Duty cycle” parameter can be specified for triangle and square. Enter the number from 0 to 100 to this edit box.

5.2. The Math editor

The Math editor can work in two operating modes. Clicking the “Advanced mode” check box selects the operating mode. If the “Advanced mode” is off, several options are not available (it is not possible to compose the waveform from several separate formulas, it is not possible to use constants Y and Z).

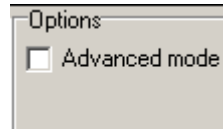

Fig. 5.2.1. – Math editor mode selection

Write formula to the “formula” edit box using functions described in the table 5.2.2.

<i>Symbol</i>	<i>Operation</i>	<i>Example</i>	<i>Description of example</i>
+	addition	$x+2$	adds 2 to x
-	remainder	$x-2$	subtracts 2 from x
*	multiplication	$x*2$	multiplies x by 2
/	division	$x/2$	divides x by 2
abs	absolute value	abs(x)	absolute value of x
sin	sine	sin(x)	sine of x
cos	cosine	cos(x)	cosine of x
^	power	x^2	x to the 2-nd
%	percentage	x%	rounded x percent of the number of samples

Table 5.2.2. – List of functions

When entering expressions, brackets can be used in the conventional mathematical mode. For example $(2+x)^{(x-2)}$ for $x=3$ results in 5.

Also the constant $\pi = 2*\arccos(0)$ is defined. The formula $\sin(\pi/2)$ is correct and its result is 1.

It is necessary to specify the range of the X variable. You can do so by writing the X value of the first generated point to the “Real start” edit box, and the X value of the last generated point to the “Real end” edit box.

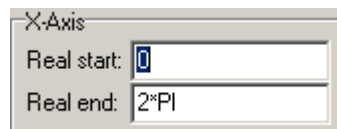

Fig. 5.2.3. – x range setting

The normalization is turned on/off by clicking the “Normalization” checkbox. If turned on, the waveform is resized to fit the dynamic range of the DA convertor.

Clicking the “Count” button calculates and displays the waveform.

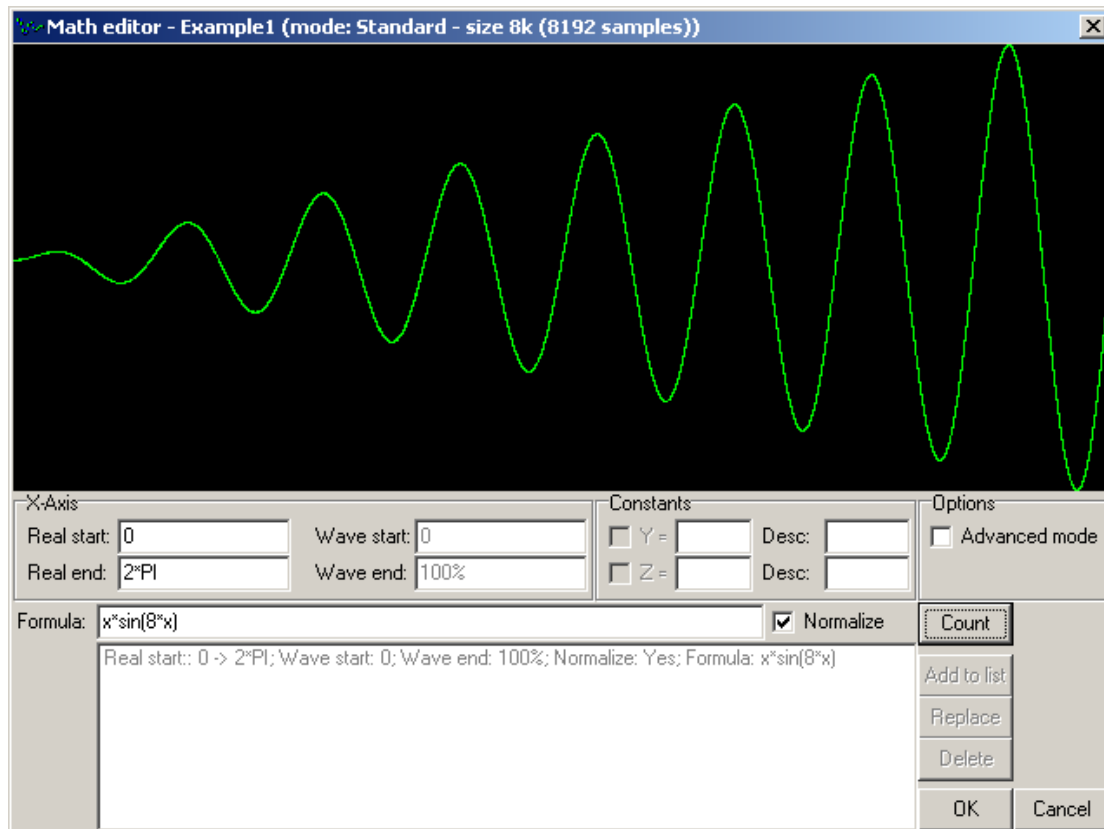

Fig. 5.2.4. – Output waveform calculated with “Normalization” option on

If the “Normalization” is switched off, it is necessary to ensure the waveform size in respect to dynamic range of the DA converter manually. Please note, that the dynamic range of the DA converter is 0 to 4095, where the 2048 value generates 0V on the output.

Following formula describes the waveform similar to the waveform on the figure 5.2.4.

Formula: $2048 + (2047 * x / (2 * \text{PI})) * \sin(8 * x)$

Please see figure 5.2.5. for the shape of the described waveform.

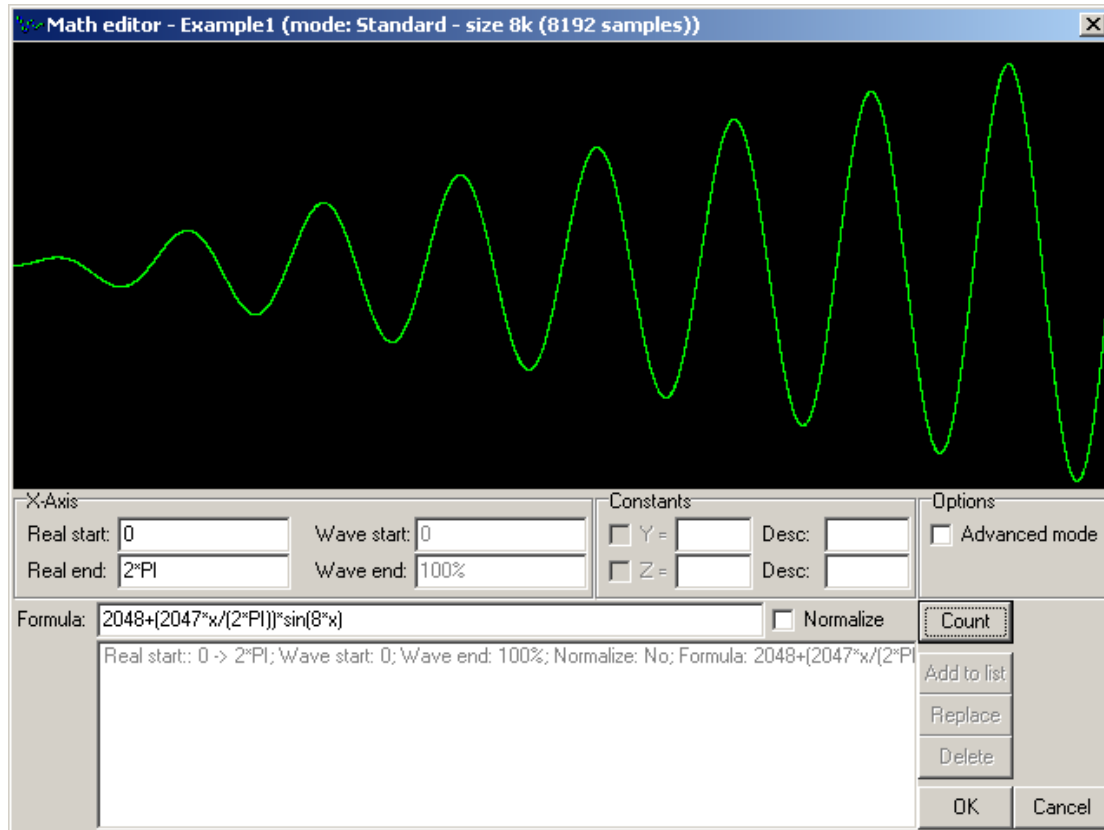

Fig. 5.2.5. Defining waveform with “Normalize” option off

The “Advanced mode” allows you to create more complicated waveforms, since it is possible to split the waveform into sections and each section can be described by separate formula.

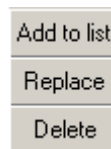

Fig. 5.2.6. – Manipulating with sections

Click “Add to list” to add formula (written in the “Formula” edit box) to the list of waveform sections.

Double-clicking any section in the list fills the section-dependent edit boxes with selected section values. Click “Replace” button to update the selected section with values filled in edit boxes.

Clicking “Delete” button removes section from the list.

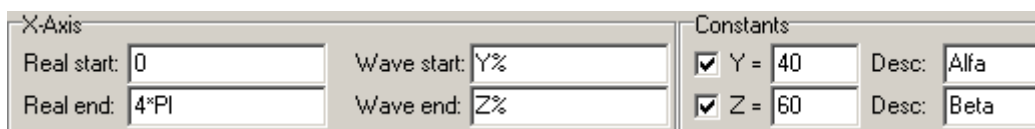

Fig. 5.2.7. – Parameters of the section in advanced mode

Except the formula, each section is defined by following parameters:

- “Real start” and “Real end” specify the range of the X variable (“Real start” is the X value for the first point of the section and “Real end” is the X value for the last point of the section).

- “Wave start” and “Wave end” specify the location of the section in the waveform. These values depend on the waveform length, therefore we recommend to use “%” function.

The mathematical editor offers the possibility to include two independent constants: y,z within the expression. The use of these constants is switched on/off by clicking on the belonging letter placed below the text “Constants”. An edit box with the current value of the constant is displayed on the right from the letter. The value can be changed by entering a new value into the field.

If you want to define the waveform of two periods of a sine wave and 0V constant voltage, you can do so by following these steps:

- create a new waveform (whole waveform is constant 0V)
 - define “sin(x)” formula with “Real start” = 0, “Real end” = $4 \cdot \text{PI}$, “Wave start” = 25% and “Wave end”=75%. This definition changes only the middle section of the waveform, the rest remains intact. Check the “Normalize” checkbox before adding the waveform to the list. The normalization flag can be set independently for each section, but please note, that the normalization parameters are calculated (the maximum and minimum of the waveform) from all sections, which has this flag on.

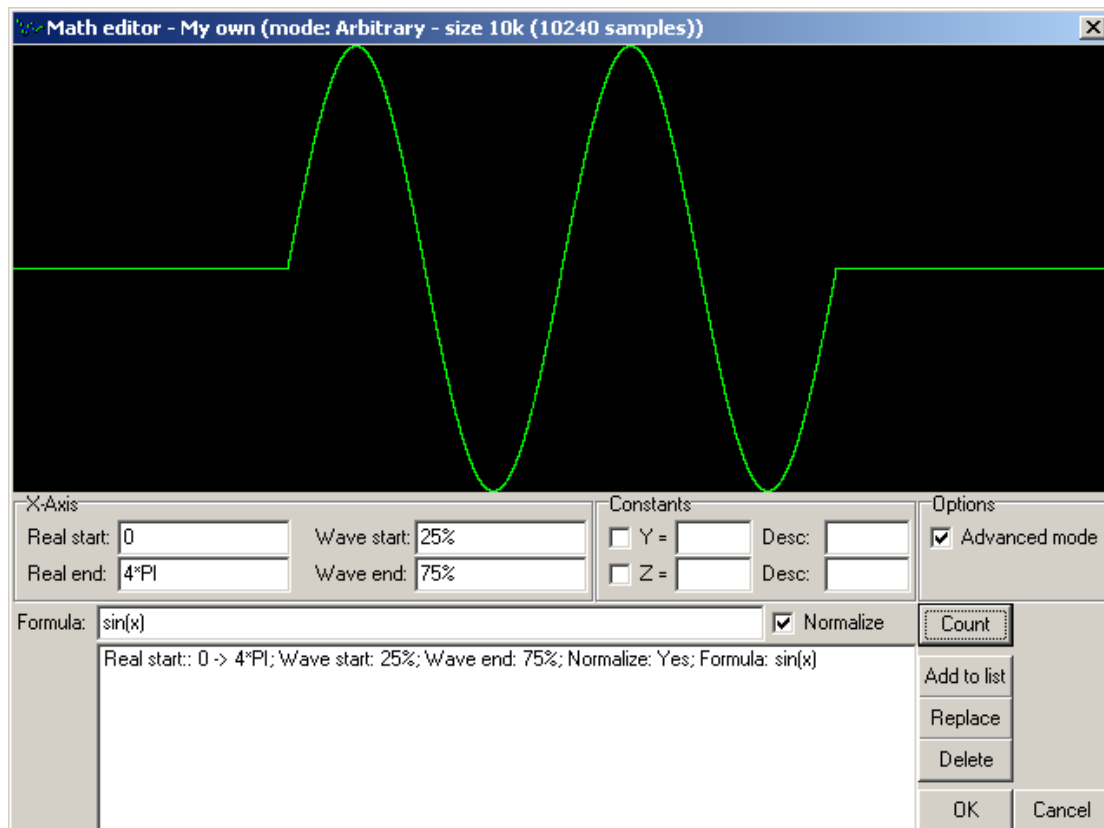

Fig. 5.2.8. – Defining part of the waveform

Figure 5.2.8. shows the waveform assembled from three parts.

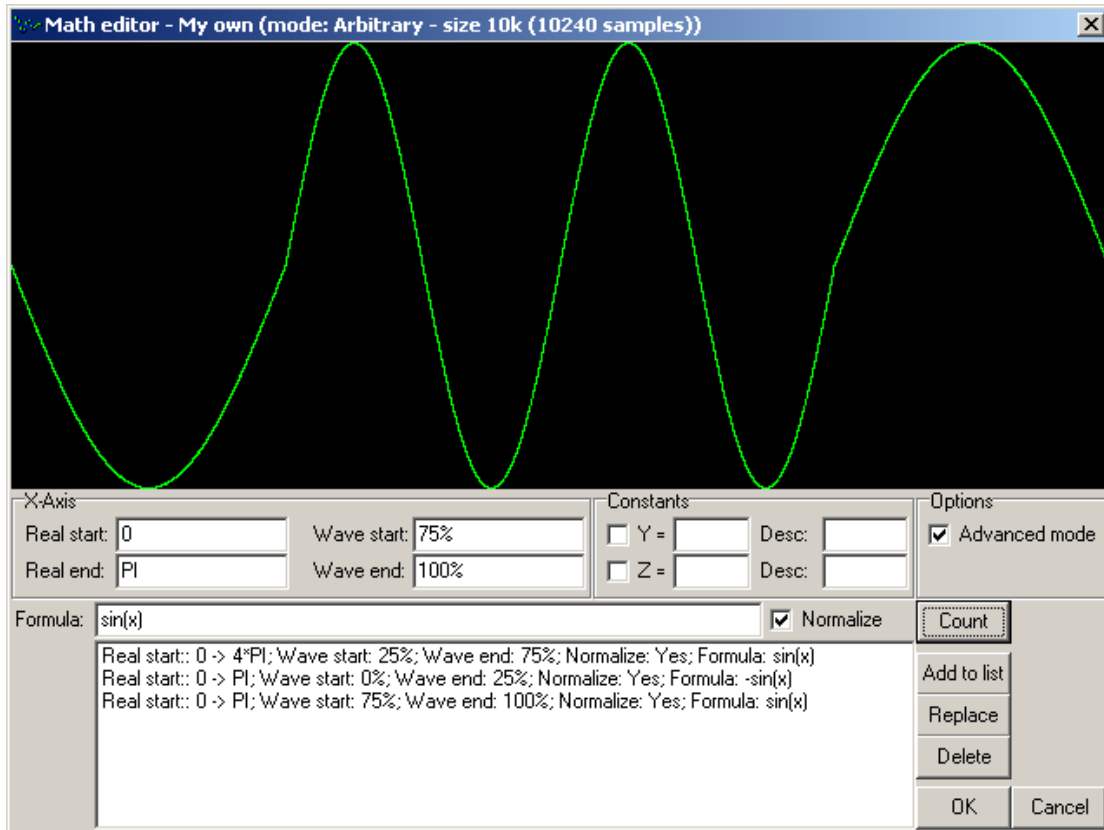

Fig. 5.2.9. - Waveform assembled from three parts

“Y” and “Z” parameters can be used for the fast and effective alternation of the waveform shape.

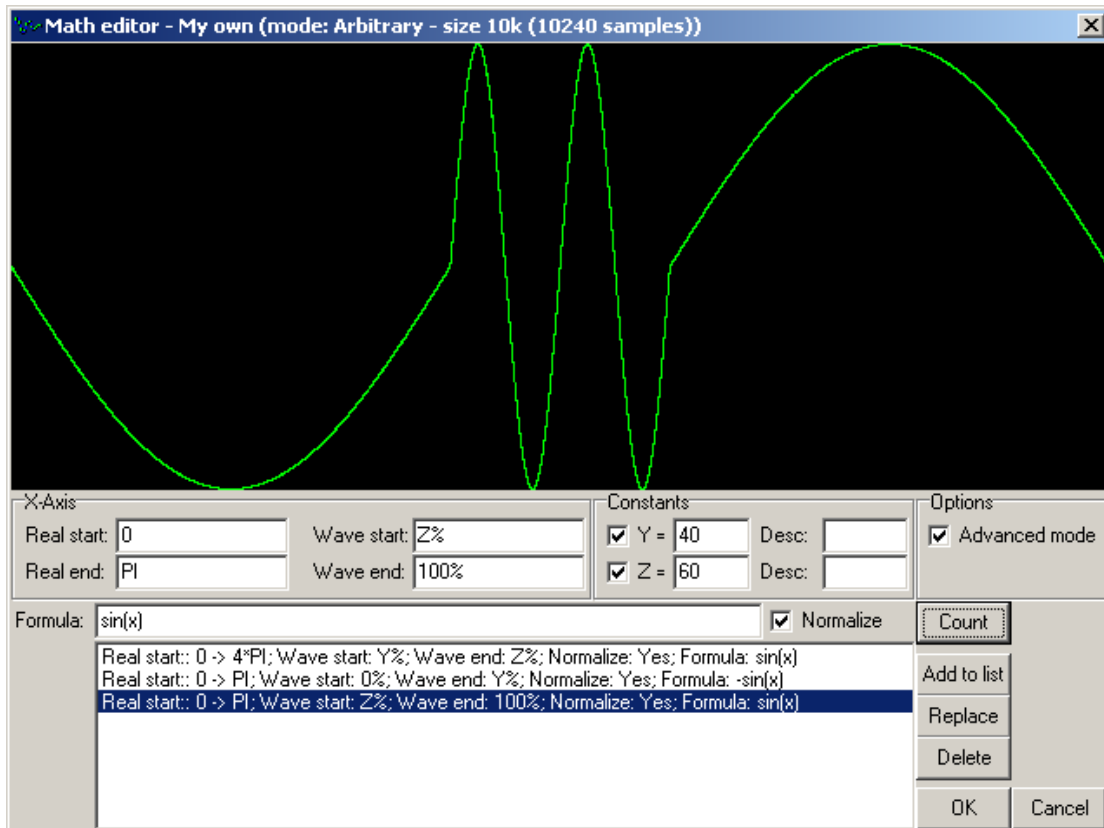

Fig. 5.2.10. – Using “Y” and “Z” constants

Figure 5.2.9. shows the example of using constants.

WARNING: The formulas are calculated in same order as they are defined in the list. When any two sections overlap, the value of the last calculated formula is used.

5.3. Freeform editor

The freeform editor allows you to modify existing waveforms. The main screen is divided into several parts.

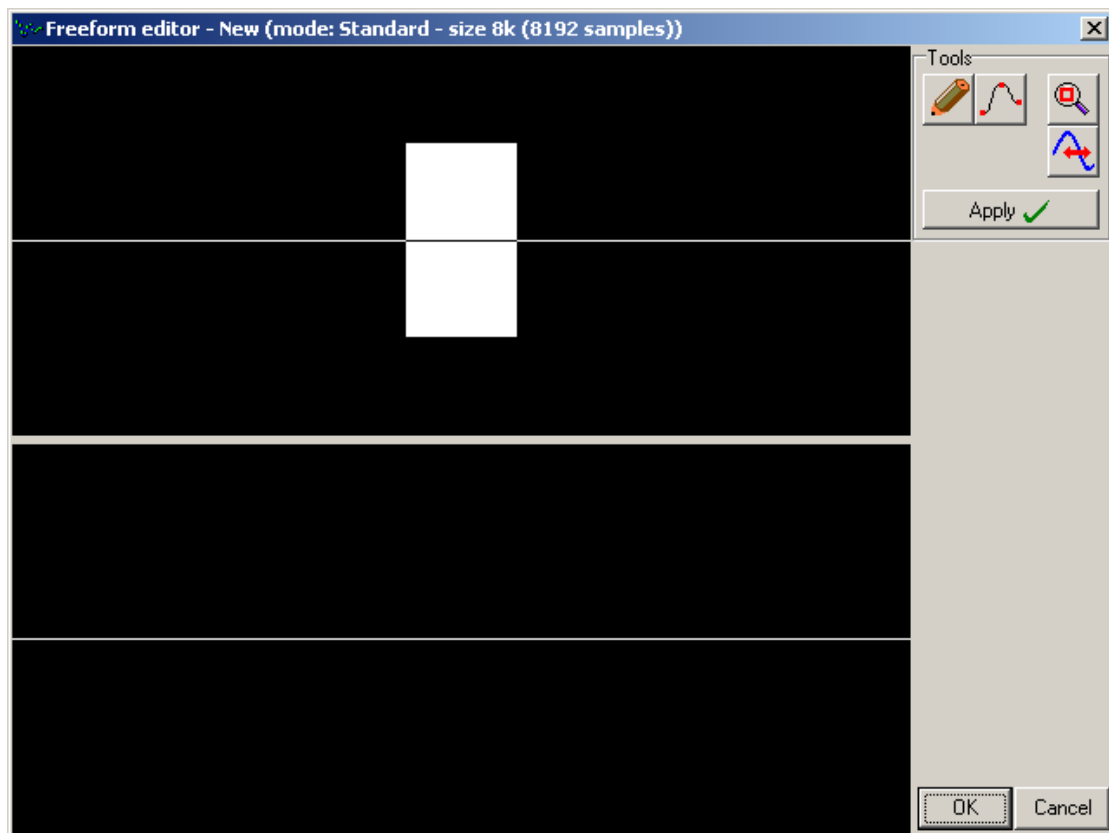



Fig. 5.3.1. – The freeform editor main screen

The top screen displays the whole waveform, while the bottom one displays selected area of the waveform. To resize the selected area, follow these steps:

- Click  button
- Select the area in the top screen by mouse

Click the  button to activate the mode, where the waveform can be cyclically moved on the X axis by dragging it. The actual shift of the waveform is displayed in the “Position” edit box located in “Wave position” panel.

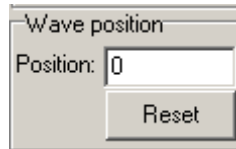



Fig. 5.3.2. – Horizontal waveform position controls

Click “Reset” button to move the waveform back to the original position. Click “Apply” button to apply changes made to the waveform.

The waveform can be edited by following two tools:

- The “freeform” mode is activated by clicking the  button. Keep left button clicked on the screen and move the mouse to draw the waveform. If the “Allow backtrack” is turned off, it is possible to draw only from the left to right. Click “Apply” button to apply changes made to the waveform.

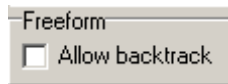



Fig. 5.3.3. – Direction of drawing

- The “Curve” mode is activated by clicking the  button. This mode allows you to create the part of the waveform as the curve defined by specified points. The “Curve” panel is displayed after this mode is selected. Clicking either top or bottom screen creates new point of the curve.

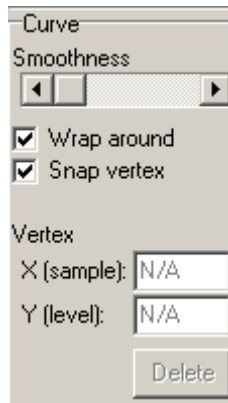

Fig. 5.3.4. – Curve mode controls

If the “Wrap around” is turned on and there are the curve points at the start and end of the waveform, changing the vertical position of any of these points will move other one to the same position. This ensures, that the waveform will be continuous.

If the “Snap vertex” is turned on, the vertical position of the excessive points of the curve copies original waveform. This ensures smooth connection to original waveform (if editing only the part of the waveform).

Selected point (you can select point by clicking it) is displayed in red. Enter value to the “X (sample):” or “Y (level):” edit box to change the position of the point.. Click “Delete” button to remove selected point.

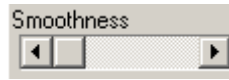

Fig. 5.3.5. – Smoothness setting

The points define the new curve between excessive points. The smoothness of the curve can be defined by using “Smoothness” scroll bar.

TIP: If the excessive points are located at the beginning and end of the waveform, the editor ensures zero first derivation of the curve in these points. To override this behaviour, move the waveform on the X axis as described in previous text.

Click “Apply” button to apply changes made to waveform.

5.4. Import from ASCII

The “Import from ASCII” module allows you to import the data from ASCII file. After activating the module, the window, where you can select source file, opens. The module tries to automatically determine the file format and load data.

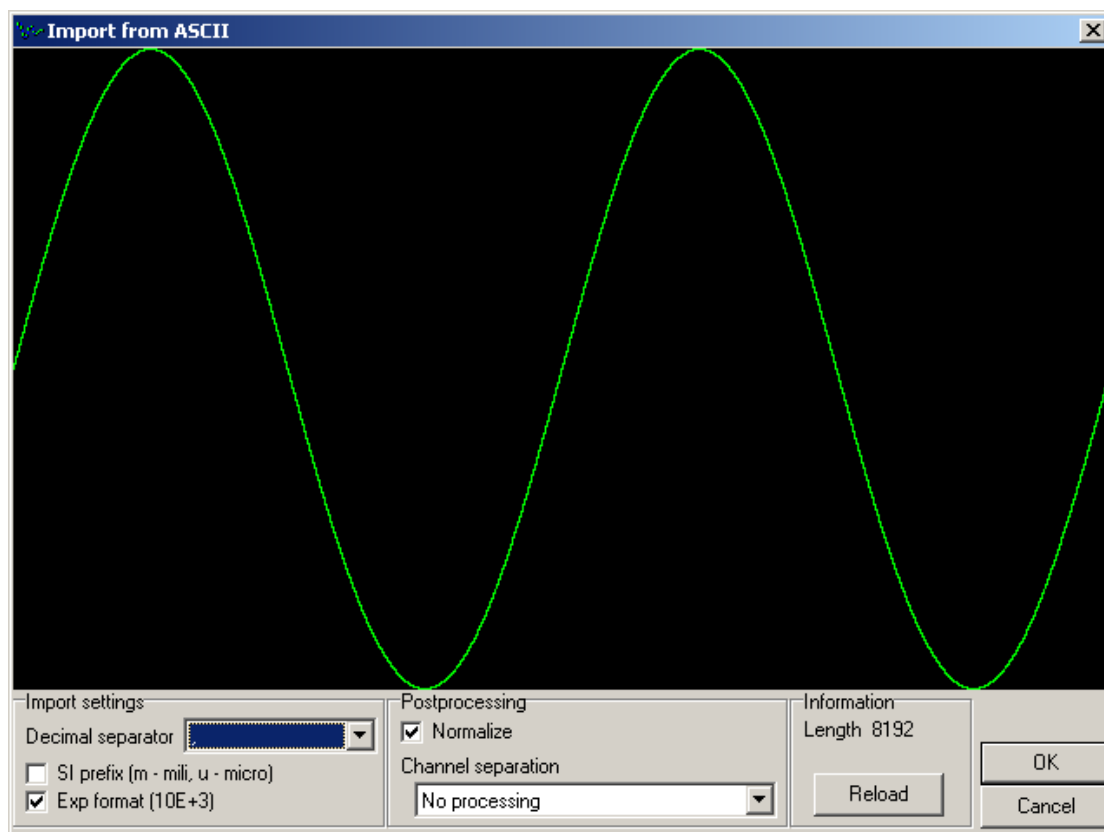

Fig. 5.4.1. – Import from ASCII file

Module tries to recognize numbers in the file, which are separated by non-number characters. Valid number characters are:

- numbers from 0 to 9
- plus (+)

- minus (-)
- dash (,), in case the decimal separator = , is selected
- dot (.), in case the decimal separator = . is selected
- character m (m) and u (u), in case the SI prefix is selected
- character E (E), in case the Exp format is selected

The parameters, that were automatically determined by the software can be altered in the panels.

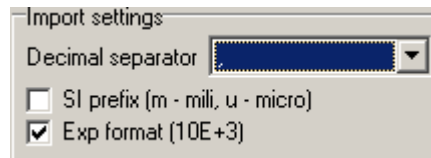

Fig. 5.4.2. – Import settings

The decimal separator can be selected in the “Decimal separator” combo box.

If the “SI prefix” is selected, the software will divide all numbers followed by m by 1000 and by u by 1000000.

If the “Exp format” is selected, the exponential format of the number is accepted (for example 1E+3 equals to 1000).

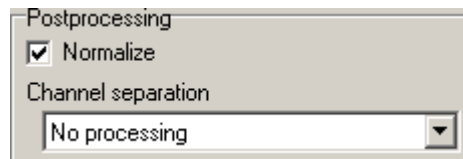

Fig. 5.4.3. – Postprocessing settings

If the “Normalize” is selected, software performs normalization. The waveform is resized to meet dynamic range of the DA converter.

In case the ASCII file contains more than one channel, it is possible to import every second sample from the file. This allows to import shape of just one channel.

6. Performance characteristics

6.1. Outputs

Number of channels	1
Number of outputs	2, low and high level (L a H)
Output attenuator	Settable to 0 or -20dB on L output
Max. output voltage, output L, no load	-4.5V to 4.5V (9Vpp) attenuator set to 0dB -450mV to 450mV (900mVpp) attenuator set to -20 dB
Max output voltage, output H no load	-25V to 25V (50Vpp)
Recommended range of output voltage setting, output L, no load	800mVpp to 9Vpp attenuator set to 0dB 80mVpp to 900mVpp attenuator set to -20 dB
Recommended range of output voltage setting, output H, no load	4.6Vpp to 50Vpp
Output voltage setting step, output L, no load	< 2.5mV (attenuator set to 0dB) < 250uV (attenuator set to -20 dB)
Output voltage setting step, output H, no load	< 13mV
Output voltage setting accuracy	Output L: +-2% from the actual value in recommended range up to 10 MHz. Output H: +- 2.5% from actual value in recommended range up to 100 kHz +5% from 100kHz to 200kHz
Output voltage shift range, output L, no load	+1.5V attenuator set to 0dB +150mV attenuator set to -20 dB
Output voltage shift range, output H, no load	+8V
Shift setting accuracy, output L	+1.5% from whole range
Shift setting accuracy, output H	+2% from whole range
Output resistance, output L	50Ohm
Output resistance, output H	600Ohm
Output resistance accuracy, output L	+1.5% attenuator set to 0dB +2%, -0.5%, attenuator set to -20 dB
Output resistance accuracy, output H	+1.5%
Filter	Settable to 20MHz, 40MHz or off
Output pulse edge length, output L	< 10ns, filter off
Output pulse edge length, output H	< 2.5us
Short circuit protection	Unlimited

Table 6.1.1. – Outputs

6.2. Waveform generation

Waveform memory length	8192 samples in “standard“ mode, maximally 16384 samples in „arbitrary“ mode
------------------------	--

Frequency setting step	< 0.003% from actual value
Frequency accuracy	0.01% from actual value
Maximum output update rate	100 000 000 samples/s
Output waveform period length	2mHz to 50MHz *
Modes of operation	Periodic, single or triggered

Table 6.2.1. – Waveform generation

* - The period consists of two points, when period length is 50MHz

6.3. Synchro

Trigger input	3.3V CMOS compatible
Trigger input threshold voltage	about 1.6V
Trigger input maximum input range	-10V to +13V
Trigger output	3.3V CMOS compatible

Table 6.3.1. – Synchro

6.4. Power

Power sources	- USB interface via USB cable - In order to activate high voltage output (H), auxiliary 10V to 18VDC power supply is required (wall adaptor is the part of the package).
Power consumption	- max. 480mA from USB - 1.2W to 2.25W from auxiliary power supply (depending on the output voltage and load of the high voltage output)

Table 6.4.1. – Power

6.5. Mechanical characteristics

Dimensions with no feet and connectors	165 x 111 x 35 mm
Dimensions with feet and connectors	182 x 111 x 39 mm
Weight	530 g

Table 6.5.1. – Mechanical characteristics